

## Description

The DCSDxx-L is designed to replace multilayer varistors(MLVs) in portable applications such as cell phones, notebook computers and PDA's, using monolithic silicon technology to provide fast response time and ultra low ESD clamping voltage, making this device an ideal solution for protecting sensitive semiconductor components from damage. The DCSDxx-L complies with the IEC 61000-4-2 (ESD) standard with  $\pm 30\text{kV}$  air and  $\pm 30\text{kV}$  contact discharge. It is assembled into a lead-free SOD-323 package and will protect one unidirectional line. These devices will fit on the same PCB pad area as an 0805 MLV device.

## Features

- ◆ 150W peak pulse power (8/20 $\mu\text{s}$ )
- ◆ Protects one data or power line
- ◆ Ultra low leakage: nA level
- ◆ Operating voltage: 3.3V,5V,8V
- ◆ Ultra low clamping voltage
- ◆ Complies with following standards:
  - IEC 61000-4-2 (ESD) immunity test  
Air discharge:  $\pm 30\text{kV}$   
Contact discharge:  $\pm 30\text{kV}$
  - IEC61000-4-4 (EFT) 40A (5/50ns)
- ◆ RoHS Compliant

## Mechanical Characteristics

- ◆ Package: SOD-323
- ◆ Lead Finish: Matte Tin
- ◆ Case Material: "Green" Molding Compound.
- ◆ UL Flammability Classification Rating 94V-0
- ◆ Moisture Sensitivity: Level 3 per J-STD-020
- ◆ Terminal Connections: See Diagram Below
- ◆ Marking Information: See Below

## Applications

- ◆ Cellular Handsets and Accessories
- ◆ Personal Digital Assistants
- ◆ Notebooks and Handhelds
- ◆ Portable Instrumentation
- ◆ Peripherals
- ◆ Pagers Peripherals
- ◆ Desktop and Servers

## Dimensions and Pin Configuration

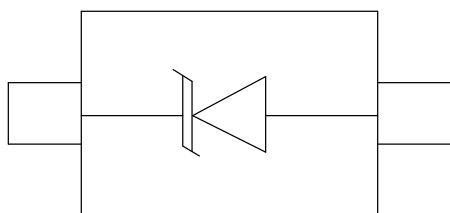

Circuit and Pin Schematic

## Marking Information



xxDL = Device Marking Code  
xx represents the voltage  
Bar denotes Cathode

## Ordering Information

Part Number	Marking	Packaging	Reel Size
DCSDxx-L	xxDL	3000/Tape & Reel	7 inch

### Absolute Maximum Ratings ( $T_A=25^\circ\text{C}$ unless otherwise specified)

Parameter	Symbol	Value	Unit
ESD per IEC 61000-4-2 (Air)	V <sub>ESD</sub>	±30	kV
ESD per IEC 61000-4-2 (Contact)		±30	
Operating Temperature Range	T <sub>J</sub>	-55 to +125	°C
Storage Temperature Range	T <sub>stg</sub>	-55 to +150	°C

### Electrical Characteristics ( $T_A=25^\circ\text{C}$ unless otherwise specified)

DCSD03-L (Marking Code: 03DL)						
Parameter	Symbol	Min	Typ	Max	Unit	Test Condition
Reverse Working Voltage	V <sub>RWM</sub>			3.3	V	
Breakdown Voltage	V <sub>BR</sub>	4			V	I <sub>T</sub> = 1mA
Reverse Leakage Current	I <sub>R</sub>			0.5	μA	V <sub>RWM</sub> = 3.3V
Forward Voltage	V <sub>F</sub>		0.8	1.2	V	I <sub>F</sub> = 10mA
Clamping Voltage	V <sub>C</sub>		5		V	I <sub>PP</sub> = 1A (8 x 20μs pulse)
Clamping Voltage	V <sub>C</sub>		10		V	I <sub>PP</sub> = 10A (8 x 20μs pulse)
Peak Pulse Current	I <sub>PP</sub>			10	A	t <sub>p</sub> = 8/20μs
Junction Capacitance	C <sub>J</sub>			60	pF	V <sub>R</sub> = 0V, f = 1MHz

DCSD05-L (Marking Code: 05DL)						
Parameter	Symbol	Min	Typ	Max	Unit	Test Condition
Reverse Working Voltage	$V_{RWM}$			5	V	
Breakdown Voltage	$V_{BR}$	6			V	$I_T = 1\text{mA}$
Reverse Leakage Current	$I_R$			0.5	$\mu\text{A}$	$V_{RWM} = 5\text{V}$
Forward Voltage	$V_F$		0.8	1.2	V	$I_F = 10\text{mA}$
Clamping Voltage	$V_C$		7		V	$I_{PP} = 1\text{A}$ (8 x 20 $\mu\text{s}$ pulse)
Clamping Voltage	$V_C$		11		V	$I_{PP} = 8.5\text{A}$ (8 x 20 $\mu\text{s}$ pulse)
Peak Pulse Current	$I_{PP}$			8.5	A	$t_p = 8/20\mu\text{s}$
Junction Capacitance	$C_J$			48	pF	$V_R = 0\text{V}$ , $f = 1\text{MHz}$

DCSD08-L (Marking Code: 08DL)						
Parameter	Symbol	Min	Typ	Max	Unit	Test Condition
Reverse Working Voltage	$V_{RWM}$			8	V	
Breakdown Voltage	$V_{BR}$	8.5			V	$I_T = 1\text{mA}$
Reverse Leakage Current	$I_R$			0.5	$\mu\text{A}$	$V_{RWM} = 8\text{V}$
Forward Voltage	$V_F$		0.8	1.2	V	$I_F = 10\text{mA}$
Clamping Voltage	$V_C$		10		V	$I_{PP} = 1\text{A}$ (8 x 20 $\mu\text{s}$ pulse)
Clamping Voltage	$V_C$		15		V	$I_{PP} = 7\text{A}$ (8 x 20 $\mu\text{s}$ pulse)
Peak Pulse Current	$I_{PP}$			7	A	$t_p = 8/20\mu\text{s}$
Junction Capacitance	$C_J$			40	pF	$V_R = 0\text{V}$ , $f = 1\text{MHz}$

**Typical Performance Characteristics (TA=25°C unless otherwise Specified)**

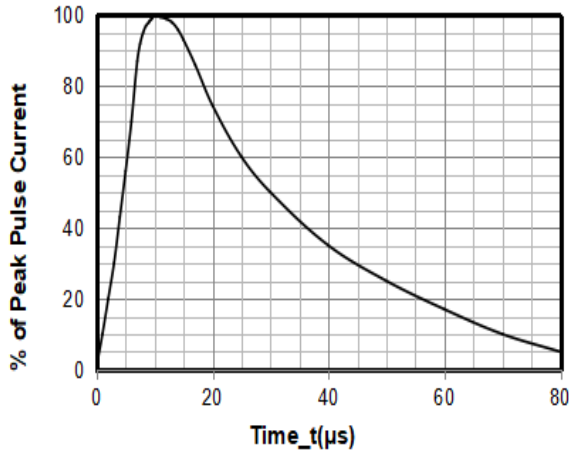

**8 X 20μs Pulse Waveform**

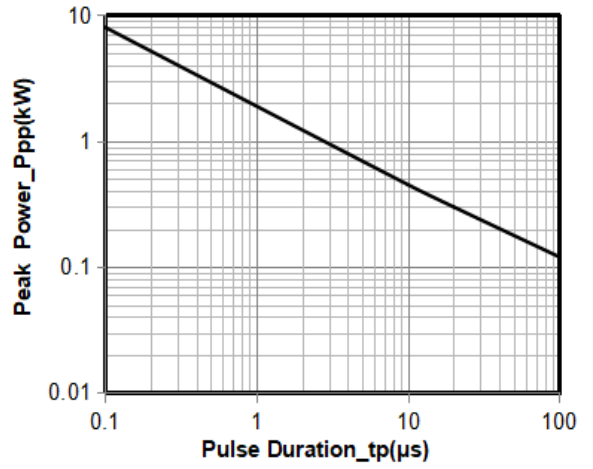

**Peak Pulse Power vs. Pulse Time**

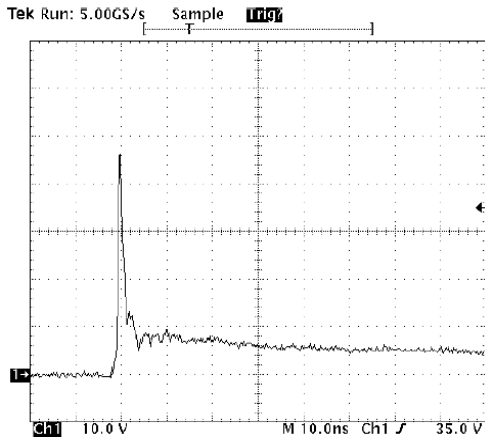

**Note: Data is taken with a 10x attenuator**  
**ESD Clamping Voltage**  
**8 kV Contact per IEC61000-4-2**

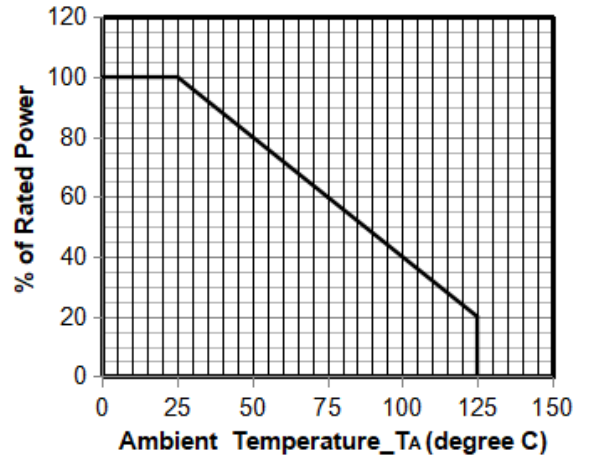

**Power Derating Curve**

## SOD-323 Package Outline Drawing

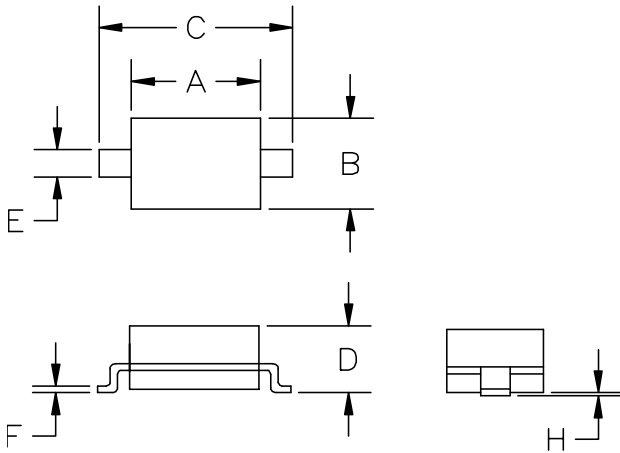

SYM	DIMENSIONS			
	MILLIMETERS		INCHES	
	MIN	MAX	MIN	MAX
A	1.50	1.80	0.060	0.071
B	1.20	1.40	0.045	0.054
C	2.30	2.70	0.090	0.107
D	-	1.10	-	0.043
E	0.30	0.40	0.012	0.016
F	0.10	0.25	0.004	0.010
H	-	0.10	-	0.004

## Suggested Land Pattern

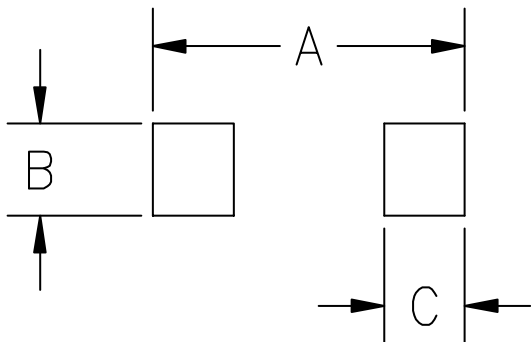

SYM	DIMENSIONS	
	MILLIMETERS	INCHES
A	3.15	0.120
B	0.80	0.031
C	0.80	0.031

## Contact Information

Changzhou D-first Electronics CO.,Ltd.

[www.first-electronic.com](http://www.first-electronic.com)

Email: [xhf@first-electronic.cn](mailto:xhf@first-electronic.cn)

Phone: +86 (0519) 8817 1671